

Pulse propagation and time reversal in random waveguides

Context: time-reversal experiments in underwater acoustics.

Experimental observations:

- robust spatial refocusing
- diffraction-limited focal spot

[1] W. A. Kuperman, W. S. Hodgkiss, H. C. Song, T. Akal, C. Ferla, and D. R. Jackson, Phase conjugation in the ocean, experimental demonstration of an acoustic time-reversal mirror, *J. Acoust. Soc. Am.* **103** (1998), 25-40.

[2] H. C. Song, W. A. Kuperman, and W. S. Hodgkiss, Iterative time reversal in the ocean, *J. Acoust. Soc. Am.* **105** (1999), 3176-3184.

Analysis of the mechanisms responsible for statistically stable time reversal.

Perfect acoustic waveguide

waveguide cross-section

$$\mathcal{D} \subset \mathbb{R}^2$$

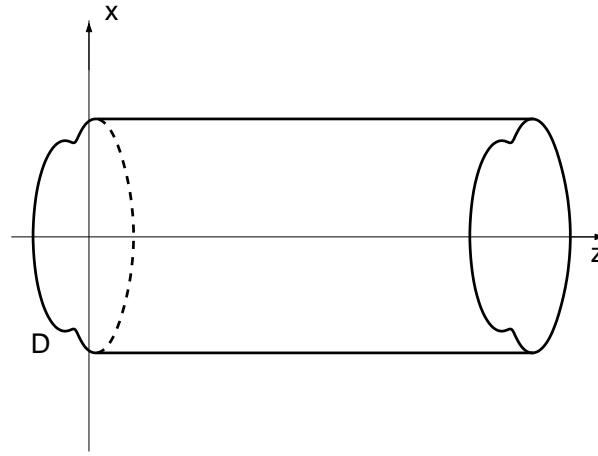

$$\bar{\rho} \frac{\partial \mathbf{u}}{\partial t} + \nabla p = \mathbf{F}, \quad \frac{1}{\bar{K}} \frac{\partial p}{\partial t} + \nabla \cdot \mathbf{u} = 0, \quad \text{for } \mathbf{x} \in \mathcal{D} \text{ and } z \in \mathbb{R}.$$

p is the acoustic pressure, \mathbf{u} is the acoustic velocity.

$\bar{\rho}$ is the density of the medium, \bar{K} is the bulk modulus.

The source is modeled by the forcing term $\mathbf{F}(t, \mathbf{r})$.

Wave equation with the sound speed $\bar{c} = \sqrt{\bar{K}/\bar{\rho}}$:

$$\Delta p - \frac{1}{\bar{c}^2} \frac{\partial^2 p}{\partial t^2} = \nabla \cdot \mathbf{F} \quad \text{for } \mathbf{x} \in \mathcal{D} \text{ and } z \in \mathbb{R}.$$

Dirichlet boundary conditions

$$p(t, \mathbf{x}, z) = 0 \quad \text{for } \mathbf{x} \in \partial \mathcal{D} \text{ and } z \in \mathbb{R}.$$

Time harmonic wave equation $k = \omega/\bar{c}$

$$\partial_z^2 \hat{p}(\omega, \mathbf{x}, z) + \Delta_{\perp} \hat{p}(\omega, \mathbf{x}, z) + k^2(\omega) \hat{p}(\omega, \mathbf{x}, z) = 0$$

Spectrum of Δ_{\perp} with Dirichlet BC = infinite number of discrete eigenvalues

$$-\Delta_{\perp} \phi_j(\mathbf{x}) = \lambda_j \phi_j(\mathbf{x}), \quad \mathbf{x} \in \mathcal{D}, \quad \phi_j(\mathbf{x}) = 0, \quad \mathbf{x} \in \partial\mathcal{D}, \quad \text{for } j = 1, 2, \dots$$

Number of propagating modes $N(\omega)$:

$$\lambda_{N(\omega)} \leq k(\omega) < \lambda_{N(\omega)+1},$$

Propagating modes $1 \leq j \leq N(\omega)$:

$$\hat{p}_j(\omega, \mathbf{x}, z) = \phi_j(\mathbf{x}) e^{\pm i\beta_j(\omega)z}, \quad \beta_j(\omega) = \sqrt{k^2(\omega) - \lambda_j}.$$

Evanescent modes $j > N(\omega)$:

$$\hat{q}_j(\omega, \mathbf{x}, z) = \phi_j(\mathbf{x}) e^{\pm \beta_j(\omega)z}, \quad \beta_j(\omega) = \sqrt{\lambda_j - k^2(\omega)}.$$

Excitation Conditions for a Source

Source localized in the plane $z = 0$:

$$\mathbf{F}(t, \mathbf{x}, z) = f(t)\delta(\mathbf{x} - \mathbf{x}_0)\delta(z)\mathbf{e}_z .$$

$$\begin{aligned} \hat{p}(\omega, \mathbf{x}, z) = & \left[\sum_{j=1}^N \frac{\hat{a}_j(\omega)}{\sqrt{\beta_j(\omega)}} e^{i\beta_j z} \phi_j(\mathbf{x}) + \sum_{j=N+1}^{\infty} \frac{\hat{c}_j(\omega)}{\sqrt{\beta_j(\omega)}} e^{-\beta_j z} \phi_j(\mathbf{x}) \right] \mathbf{1}_{(0,\infty)}(z) \\ & + \left[\sum_{j=1}^N \frac{\hat{b}_j(\omega)}{\sqrt{\beta_j(\omega)}} e^{-i\beta_j z} \phi_j(\mathbf{x}) + \sum_{j=N+1}^{\infty} \frac{\hat{d}_j(\omega)}{\sqrt{\beta_j(\omega)}} e^{\beta_j z} \phi_j(\mathbf{x}) \right] \mathbf{1}_{(-\infty,0)}(z) , \end{aligned}$$

with

$$\begin{aligned} \hat{a}_j(\omega) = -\hat{b}_j(\omega) &= \frac{\sqrt{\beta_j(\omega)}}{2} \hat{f}(\omega) \phi_j(\mathbf{x}_0) , \\ \hat{c}_j(\omega) = -\hat{d}_j(\omega) &= -\frac{\sqrt{\beta_j(\omega)}}{2} \hat{f}(\omega) \phi_j(\mathbf{x}_0) . \end{aligned}$$

For $k(\omega)z \gg 1$:

$$\hat{p}(\omega, \mathbf{x}, z) = \sum_{j=1}^{N(\omega)} \frac{\hat{a}_j(\omega)}{\sqrt{\beta_j(\omega)}} \phi_j(\mathbf{x}) e^{i\beta_j(\omega)z}$$

Perturbed waveguide: Time harmonic approach

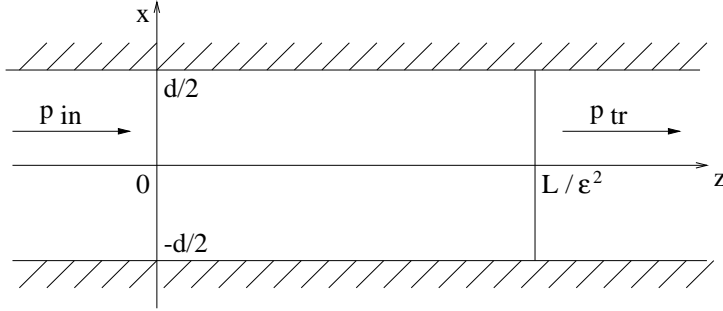

$$\rho(\mathbf{r}) \frac{\partial \mathbf{u}}{\partial t} + \nabla p = \mathbf{F},$$

$$\frac{1}{K(\mathbf{r})} \frac{\partial p}{\partial t} + \nabla \cdot \mathbf{u} = 0,$$

$$\frac{1}{K(\mathbf{x}, z)} = \begin{cases} \frac{1}{\bar{K}} (1 + \varepsilon \nu(\mathbf{x}, z)) & \text{for } \mathbf{x} \in \mathcal{D}, \quad z \in [0, L/\varepsilon^2] \\ \frac{1}{\bar{K}} & \text{for } \mathbf{x} \in \mathcal{D}, \quad z \in (-\infty, 0) \cup (L/\varepsilon^2, \infty) \end{cases}$$

$$\rho(\mathbf{x}, z) = \bar{\rho} \quad \text{for } \mathbf{x} \in \mathcal{D}, \quad z \in (-\infty, \infty)$$

Perturbed wave equation with Dirichlet boundary conditions:

$$\Delta \hat{p}(\omega, \mathbf{x}, z) + k^2 (1 + \varepsilon \nu(\mathbf{x}, z)) \hat{p}(\omega, \mathbf{x}, z) = 0.$$

Wave mode expansions:

$$\hat{p}(\mathbf{x}, z) = \sum_{j=1}^N \phi_j(\mathbf{x}) \hat{p}_j(z) + \sum_{j=N+1}^{\infty} \phi_j(\mathbf{x}) \hat{q}_j(z)$$

Right-going and left-going mode amplitudes $\hat{a}_j(z)$ and $\hat{b}_j(z)$:

$$\hat{p}_j = \frac{1}{\sqrt{\beta_j}} \left(\hat{a}_j e^{i\beta_j z} + \hat{b}_j e^{-i\beta_j z} \right), \quad \frac{d\hat{p}_j}{dz} = i\sqrt{\beta_j} \left(\hat{a}_j e^{i\beta_j z} - \hat{b}_j e^{-i\beta_j z} \right), \quad j \leq N$$

Coupled mode equations

Neglect evanescent modes.

Coupled mode equations for $j \leq N$:

$$\frac{d\hat{a}_j}{dz} = \frac{i\varepsilon k^2}{2} \sum_{1 \leq l \leq N} \frac{C_{jl}(z)}{\sqrt{\beta_j \beta_l}} \left(\hat{a}_l e^{i(\beta_l - \beta_j)z} + \hat{b}_l e^{-i(\beta_l + \beta_j)z} \right)$$

$$\frac{d\hat{b}_j}{dz} = -\frac{i\varepsilon k^2}{2} \sum_{1 \leq l \leq N} \frac{C_{jl}(z)}{\sqrt{\beta_j \beta_l}} \left(\hat{a}_l e^{i(\beta_l + \beta_j)z} + \hat{b}_l e^{i(\beta_j - \beta_l)z} \right)$$

where

$$C_{jl}(z) = \int_{\mathcal{D}} \phi_j(\mathbf{x}) \phi_l(\mathbf{x}) \nu(\mathbf{x}, z) d\mathbf{x}$$

Boundary conditions:

$$\hat{a}_j(0) = \hat{a}_{j,0}, \quad \hat{b}_j\left(\frac{L}{\varepsilon^2}\right) = 0$$

Rescaling:

$$\hat{a}_j^\varepsilon(z) = \hat{a}_j\left(\frac{z}{\varepsilon^2}\right), \quad \hat{b}_j^\varepsilon(z) = \hat{b}_j\left(\frac{z}{\varepsilon^2}\right)$$

↪ Diffusion approximation theorem.

The forward scattering approximation

Diffusion-approximation \implies multi-dimensional diffusion process.

Coupling coefficients between left and right-going modes:

$$\int_0^\infty \mathbb{E}[C_{jl}(0)C_{jl}(z)] \cos(\beta_j(\omega) + \beta_l(\omega))z \, dz, \quad j, l = 1, \dots, N(\omega).$$

Coupling coefficients between right-going modes:

$$\int_0^\infty \mathbb{E}[C_{jl}(0)C_{jl}(z)] \cos(\beta_j(\omega) - \beta_l(\omega))z \, dz, \quad j, l = 1, \dots, N(\omega).$$

We can neglect the left-going (backward) propagating modes if the first type of coefficients are negligible compared to the second ones.

\rightarrow reduced system:

$$\begin{aligned} \frac{d\hat{a}^\varepsilon}{dz} &= \frac{1}{\varepsilon} M\left(\frac{z}{\varepsilon^2}\right) \hat{a}^\varepsilon(z) \\ M_{jl}(z) &= \frac{ik^2}{2\sqrt{\beta_j\beta_l}} C_{jl}(z) e^{i(\beta_l - \beta_j)z} \end{aligned}$$

The mode amplitudes $(\hat{a}_j^\varepsilon(\omega, z))_{j=1, \dots, N}$ converge in distribution as $\varepsilon \rightarrow 0$ to a **diffusion process** $(\hat{a}_j(\omega, z))_{j=1, \dots, N}$ whose infinitesimal generator is

$$\begin{aligned} \mathcal{L} &= \frac{1}{4} \sum_{j \neq l} \Gamma_{jl}^{(c)}(\omega) (A_{jl} \overline{A_{jl}} + \overline{A_{jl}} A_{jl}) + \frac{1}{2} \sum_{j, l} \Gamma_{jl}^{(1)}(\omega) A_{jj} \overline{A_{ll}} \\ &\quad + \frac{i}{4} \sum_{j \neq l} \Gamma_{jl}^{(s)}(\omega) (A_{ll} - A_{jj}), \end{aligned}$$

$$A_{jl} = \hat{a}_j \frac{\partial}{\partial \hat{a}_l} - \overline{\hat{a}_l} \frac{\partial}{\partial \hat{a}_j} = -\overline{A_{lj}}.$$

$$\Gamma_{jl}^{(c)}(\omega) = \frac{\omega^4}{2\bar{c}^4 \beta_j(\omega) \beta_l(\omega)} \int_0^\infty \cos((\beta_j(\omega) - \beta_l(\omega))z) \mathbb{E}[C_{jl}(0)C_{jl}(z)] dz \text{ if } j \neq l,$$

$$\Gamma_{jj}^{(c)}(\omega) = - \sum_{n \neq j} \Gamma_{jn}^{(c)}(\omega),$$

Mean mode amplitudes

The expected values of the mode amplitudes $\mathbb{E}[\hat{a}_j^\varepsilon(\omega, z)]$ converge as $\varepsilon \rightarrow 0$ to $\mathbb{E}[\hat{a}_j(\omega, z)]$ given by

$$\mathbb{E}[\hat{a}_j(\omega, z)] = \exp(q_j(\omega)z) \hat{a}_{j0}(\omega)$$

$$\text{Re}(q_j(\omega)) < 0$$

↪ exponential damping of the mean amplitudes.

Mean mode powers

The mode powers $(|\hat{a}_j^\varepsilon(\omega, z)|^2)_{j=1, \dots, N}$ converge in distribution as $\varepsilon \rightarrow 0$ to $(P_j(\omega, z))_{j=1, \dots, N}$ whose infinitesimal generator is

$$\mathcal{L}_P = \sum_{j \neq l} \Gamma_{jl}^{(c)}(\omega) \left[P_l P_j \left(\frac{\partial}{\partial P_j} - \frac{\partial}{\partial P_l} \right) \frac{\partial}{\partial P_j} + (P_l - P_j) \frac{\partial}{\partial P_j} \right]$$

\hookrightarrow diffusion on $\mathcal{H}_N = \left\{ (P_j)_{j=1, \dots, N}, P_j \geq 0, \sum_{j=1}^N P_j = R_0^2 \right\}$

where $R_0^2 = \sum_{j=1}^N |\hat{a}_{j,0}|^2$

The mean mode powers $\mathbb{E}[|\hat{a}_j^\varepsilon(\omega, z)|^2]$ converge to $P_j^{(1)}(\omega, z)$

$$\frac{dP_j^{(1)}}{dz} = \sum_{n \neq j} \Gamma_{jn}^{(c)}(\omega) \left(P_n^{(1)} - P_j^{(1)} \right)$$

starting from $P_j^{(1)}(\omega, z = 0) = |\hat{a}_{j,0}|^2, j = 1, \dots, N$.

This shows the asymptotic *equipartition* of mode energy:

$$\sup_{j=1, \dots, N} \left| P_j^{(1)}(\omega, z) - \frac{1}{N} R_0^2 \right| \leq C \exp \left(-\frac{z}{L_{\text{equip}}} \right)$$

where $\frac{1}{L_{\text{equip}}} =$ second eigenvalue of $\Gamma^{(c)}$.

Fluctuations theory

$$P_{jl}^{(2)}(\omega, z) = \lim_{\varepsilon \rightarrow 0} \mathbb{E} [|\hat{a}_j^\varepsilon(\omega, z)|^2 |\hat{a}_l^\varepsilon(\omega, z)|^2] = \mathbb{E}[P_j(\omega, z)P_l(\omega, z)].$$

Using the generator \mathcal{L}_P we get a system of ordinary differential equations for limit forth moments $(P_{jl}^{(2)})_{j,l=1,\dots,N}$ which has the form

$$\frac{dP_{jj}^{(2)}}{dz} = \sum_{n \neq j} \Gamma_{jn}^{(c)} \left(4P_{jn}^{(2)} - 2P_{jj}^{(2)} \right),$$

$$\frac{dP_{jl}^{(2)}}{dz} = -2\Gamma_{jl}^{(c)} P_{jl}^{(2)} + \sum_n \Gamma_{ln}^{(c)} \left(P_{jn}^{(2)} - P_{jl}^{(2)} \right) + \sum_n \Gamma_{jn}^{(c)} \left(P_{ln}^{(2)} - P_{jl}^{(2)} \right), \quad j \neq l.$$

The normalized correlation

$$\text{Cor}(P_j, P_l)(z) := \frac{P_{jl}^{(2)}(z) - P_j^{(1)}(z)P_l^{(1)}(z)}{P_j^{(1)}(z)P_l^{(1)}(z)},$$

has the following asymptotic form

$$\text{Cor}(P_j, P_l)(z) \xrightarrow{z \rightarrow \infty} \begin{cases} -\frac{1}{N+1} & \text{if } j \neq l, \\ \frac{N-1}{N+1} & \text{if } j = l. \end{cases}$$

When N is large: P_j uncorrelated, with exponential distribution.

Narrowband pulse propagation in a random waveguide

Point-like narrowband source term

$$\mathbf{F}^\varepsilon(t, \mathbf{x}, z) = f^\varepsilon(t)\delta(\mathbf{x} - \mathbf{x}_0)\delta(z)\mathbf{e}_z$$

$$f^\varepsilon(t) = f(\varepsilon^2 t)e^{i\omega_0 t}, \quad \hat{f}^\varepsilon(\omega) = \frac{1}{\varepsilon^2} \hat{f}\left(\frac{\omega - \omega_0}{\varepsilon^2}\right)$$

Transmitted pulse:

$$p_{tr}^\varepsilon(t, \mathbf{x}, L) = p_{tr}\left(\frac{t}{\varepsilon^2}, \mathbf{x}, \frac{L}{\varepsilon^2}\right)$$

$$p_{tr}^\varepsilon(t, \mathbf{x}, L) = \frac{1}{4\pi\varepsilon^2} \int \sum_{j,l=1}^N \frac{\sqrt{\beta_l}}{\sqrt{\beta_j}} \phi_j(\mathbf{x})\phi_l(\mathbf{x}_0) \hat{f}\left(\frac{\omega - \omega_0}{\varepsilon^2}\right) \mathbf{T}_{jl}^\varepsilon(\omega) e^{i\frac{\beta_j(\omega)L - \omega t}{\varepsilon^2}} d\omega$$

where $\mathbf{T}_{jl}^\varepsilon = \hat{\mathbf{a}}_j^\varepsilon(L)$ when $\hat{\mathbf{a}}_j^\varepsilon(0) = \delta_{jl}$ (\mathbf{T}^ε : transfer matrix).

$$p_{tr}^\varepsilon(t, \mathbf{x}, L) = \frac{1}{4\pi} \int \sum_{j,l=1}^N \frac{\sqrt{\beta_l}}{\sqrt{\beta_j}} \phi_j(\mathbf{x})\phi_l(\mathbf{x}_0)$$

$$\times \hat{f}(h) \mathbf{T}_{jl}^\varepsilon(\omega_0 + \varepsilon^2 h) e^{i\frac{\beta_j(\omega_0)L - \omega_0 t}{\varepsilon^2}} e^{i[\beta_j'(\omega_0)L - t]h} dh$$

Homogeneous waveguide

In a homogeneous waveguide we have $T_{jl}^\varepsilon = \delta_{jl}$ and

$$p_{tr}^\varepsilon(t, \mathbf{x}, L) = \frac{1}{2} \sum_{j=1}^N \phi_j(\mathbf{x}) \phi_j(\mathbf{x}_0) e^{i \frac{\beta_j(\omega_0)L - \omega_0 t}{\varepsilon^2}} f(t - \beta_j'(\omega_0)L)$$

Transmitted wave = superposition of modes.

Each mode propagates with its **velocity** $1/\beta_j'(\omega_0)$.

Modal dispersion grows like $\sim L$.

Random waveguide

Mean amplitude:

$$\begin{aligned} \mathbb{E}[p_{tr}^\varepsilon(t, \mathbf{x}, L)] &= \frac{1}{4\pi} \int \sum_{j,l=1}^N \frac{\sqrt{\beta_l}}{\sqrt{\beta_j}} \phi_j(\mathbf{x}) \phi_l(\mathbf{x}_0) \\ &\times \hat{f}(h) \mathbb{E}[T_{jl}^\varepsilon(\omega_0 + \varepsilon^2 h)] e^{i \frac{\beta_j(\omega_0)L - \omega_0 t}{\varepsilon^2}} e^{i[\beta'_j(\omega_0)L - t]h} dh \end{aligned}$$

Mean intensity:

$$\begin{aligned} \mathbb{E}[p_{tr}^\varepsilon(t, \mathbf{x}, L)^2] &= \frac{1}{16\pi^2} \int \sum_{j,l,m,n=1}^N \frac{\sqrt{\beta_l}}{\sqrt{\beta_j}} \phi_j(\mathbf{x}) \phi_l(\mathbf{x}_0) \frac{\sqrt{\beta_n}}{\sqrt{\beta_m}} \phi_m(\mathbf{x}) \phi_n(\mathbf{x}_0) \\ &\times \hat{f}(h) \overline{\hat{f}(h')} \mathbb{E}[T_{jl}^\varepsilon(\omega_0 + \varepsilon^2 h) T_{mn}^\varepsilon(\omega_0 + \varepsilon^2 h')] \\ &e^{i \frac{[\beta_j(\omega_0) - \beta_m(\omega_0)]L}{\varepsilon^2}} e^{i[\beta'_j(\omega_0)L - t]h - i[\beta'_m(\omega_0)L - t]h'} dh dh' \end{aligned}$$

Autocorrelation function of the transmission coefficients

For fixed indices m and n :

$$U_{jl}^\varepsilon(\omega, h, z) = T_{jm}^\varepsilon(\omega, z) \overline{T_{ln}^\varepsilon(\omega - \varepsilon^2 h, z)}$$

is the solution of

$$\begin{aligned} \frac{dU_{jl}^\varepsilon}{dz} = & \frac{ik^2}{2\varepsilon} \left(\frac{C_{jj}(\frac{z}{\varepsilon^2})}{\beta_j(\omega)} - \frac{C_{ll}(\frac{z}{\varepsilon^2})}{\beta_l(\omega - \varepsilon^2 h)} \right) U_{jl}^\varepsilon \\ & + \frac{ik^2}{2\varepsilon} \sum_{j_1 \neq j} \frac{C_{jj_1}(\frac{z}{\varepsilon^2})}{\sqrt{\beta_j \beta_{j_1}(\omega)}} e^{i(\beta_{j_1} - \beta_j)(\omega) \frac{z}{\varepsilon^2}} U_{j_1 l}^\varepsilon \\ & - \frac{ik^2}{2\varepsilon} \sum_{l_1 \neq l} \frac{C_{ll_1}(\frac{z}{\varepsilon^2})}{\sqrt{\beta_l \beta_{l_1}(\omega - \varepsilon^2 h)}} e^{i(\beta_l - \beta_{l_1})(\omega - \varepsilon^2 h) \frac{z}{\varepsilon^2}} U_{j l_1}^\varepsilon, \end{aligned}$$

with the initial conditions $U_{jl}^\varepsilon(\omega, h, z = 0) = \delta_{mj} \delta_{nl}$.

Expand $\beta.(\omega - \varepsilon^2 h)$ with respect to ε .

Introduce the Fourier transform

$$V_{jl}^\varepsilon(\omega, \tau, z) = \frac{1}{2\pi} \int e^{-ih(\tau - \beta_l'(\omega)z)} U_{jl}^\varepsilon(\omega, h, z) dh,$$

solution of

$$\begin{aligned} \frac{\partial V_{jl}^\varepsilon}{\partial z} + \beta_l'(\omega) \frac{\partial V_{jl}^\varepsilon}{\partial \tau} &= \frac{ik^2}{2\varepsilon} \left(\frac{C_{jj}(\frac{z}{\varepsilon^2})}{\beta_j(\omega)} - \frac{C_{ll}(\frac{z}{\varepsilon^2})}{\beta_l(\omega)} \right) V_{jl}^\varepsilon \\ &+ \frac{ik^2}{2\varepsilon} \sum_{j_1 \neq j} \frac{C_{jj_1}(\frac{z}{\varepsilon^2})}{\sqrt{\beta_j \beta_{j_1}(\omega)}} e^{i(\beta_{j_1} - \beta_j)(\omega) \frac{z}{\varepsilon^2}} V_{j_1 l}^\varepsilon \\ &- \frac{ik^2}{2\varepsilon} \sum_{l_1 \neq l} \frac{C_{ll_1}(\frac{z}{\varepsilon^2})}{\sqrt{\beta_l \beta_{l_1}(\omega)}} e^{i(\beta_l - \beta_{l_1})(\omega) \frac{z}{\varepsilon^2}} V_{jl_1}^\varepsilon, \end{aligned}$$

with the initial conditions $V_{jl}^\varepsilon(\omega, h, z = 0) = \delta_{mj} \delta_{nl} \delta(\tau)$.

\hookrightarrow diffusion approximation theorem.

Autocorrelation function of the transmission coefficients

The autocorrelation function of the transmission coefficients at two nearby frequencies admits a limit as $\varepsilon \rightarrow 0$.

$$\begin{aligned} \mathbb{E}[T_{jj}^\varepsilon(\omega, L) \overline{T_{ll}^\varepsilon(\omega - \varepsilon^2 h, L)}] &\xrightarrow{\varepsilon \rightarrow 0} e^{Q_{jl}(\omega)L} \text{ if } j \neq l, \\ \mathbb{E}[T_{jl}^\varepsilon(\omega, L) \overline{T_{jl}^\varepsilon(\omega - \varepsilon^2 h, L)}] &\xrightarrow{\varepsilon \rightarrow 0} e^{-i\beta'_j(\omega)hL} \int \mathcal{W}_j^{(l)}(\omega, \tau, L) e^{ih\tau} d\tau, \\ \mathbb{E}[T_{jm}^\varepsilon(\omega, L) \overline{T_{ln}^\varepsilon(\omega - \varepsilon^2 h, L)}] &\xrightarrow{\varepsilon \rightarrow 0} 0 \text{ in the other cases,} \end{aligned}$$

where $(\mathcal{W}_j^{(l)}(\omega, \tau, z))_{j=1, \dots, N(\omega)}$ is the solution of the system of transport equations

$$\frac{\partial \mathcal{W}_j^{(l)}}{\partial z} + \beta'_j(\omega) \frac{\partial \mathcal{W}_j^{(l)}}{\partial \tau} = \sum_{n \neq j} \Gamma_{jn}^{(c)}(\omega) (\mathcal{W}_n^{(l)} - \mathcal{W}_j^{(l)})$$

starting from $\mathcal{W}_j^{(l)}(\omega, \tau, z=0) = \delta(\tau) \delta_{jl}$.

The damping coefficients $Q_{jl}(\omega) < 0 \implies$ the coherent field decays exponentially.

$$\Gamma_{jn}^{(c)} = \frac{\omega^4}{4\bar{c}^4 \beta_j(\omega) \beta_n(\omega)} \int_{-\infty}^{\infty} \cos((\beta_j(\omega) - \beta_n(\omega))z) \mathbb{E}[C_{jn}(0)C_{jn}(z)] dz > 0$$

Probabilistic representation

Let us define the jump Markov process J_z whose state space is $\{1, \dots, N(\omega)\}$ and whose infinitesimal generator is

$$\mathcal{L}\phi(j) = \sum_{l \neq j} \Gamma_{jl}^{(c)}(\omega) (\phi(l) - \phi(j)) .$$

We also define the process \mathcal{B}_z by

$$\mathcal{B}_z = \int_0^z \beta'_{J_s} ds, z \geq 0 .$$

Kolmogorov equation:

$$\int_{\tau_0}^{\tau_1} \mathcal{W}_j^{(n)}(\omega, \tau, L) d\tau = \mathbb{P}(J_L = j, \mathcal{B}_L \in [\tau_0, \tau_1] \mid J_0 = n) .$$

(J_z) is an ergodic Markov chain with uniform stationary distribution.

From the ergodic theorem we have

$$\frac{\mathcal{B}_z}{z} \xrightarrow{z \rightarrow \infty} \overline{\beta'(\omega)}, \text{ where } \overline{\beta'(\omega)} = \frac{1}{N(\omega)} \sum_{j=1}^{N(\omega)} \beta'_j(\omega)$$

Exponential convergence rate = $1/L_{\text{equip}}$

By applying a central limit theorem for functionals of ergodic Markov processes,

$$\frac{\mathcal{B}_z - \overline{\beta'(\omega)}z}{\sqrt{z}} \xrightarrow{z \rightarrow \infty} \mathcal{N}(0, \sigma_{\beta'(\omega)}^2)$$

where

$$\sigma_{\beta'(\omega)}^2 = 2 \int_0^\infty \mathbb{E}_e \left[(\beta'_{J_0}(\omega) - \overline{\beta'(\omega)}) (\beta'_{J_s}(\omega) - \overline{\beta'(\omega)}) \right] ds$$

$$\mathcal{W}_j^{(n)}(\omega, \tau, L) \stackrel{L \gg L_{\text{equip}}}{\simeq} \frac{1}{N(\omega)} \frac{1}{\sqrt{2\pi\sigma_{\beta'(\omega)}^2 L}} \exp\left(-\frac{(\tau - \overline{\beta'(\omega)}L)^2}{2\sigma_{\beta'(\omega)}^2 L}\right)$$

Diffusion approximation for the system of transport equations

$\mathcal{W}_j^{(n)}(\omega, \tau, L) \stackrel{L \gg L_{\text{equip}}}{\simeq} \mathcal{W}(\omega, \tau, L)$ with

$$\frac{\partial \mathcal{W}}{\partial z} + \overline{\beta'(\omega)} \frac{\partial \mathcal{W}}{\partial \tau} = \frac{1}{2} \sigma_{\beta'(\omega)}^2 \frac{\partial^2 \mathcal{W}}{\partial \tau^2}$$

The mean transmitted intensity

$$\mathbb{E} \left[|p_{tr}^\varepsilon(t, \mathbf{x}, L)|^2 \right] = I_1^\varepsilon(t, \mathbf{x}, L) + I_2^\varepsilon(t, \mathbf{x}, L)$$

The first term is the contribution of the coherent wave:

$$I_1^\varepsilon(t, \mathbf{x}, L) \stackrel{\varepsilon \rightarrow 0}{\simeq} \frac{1}{4} \sum_{j \neq m=1}^N \phi_j(\mathbf{x}) \phi_j(\mathbf{x}_0) \phi_m(\mathbf{x}) \phi_m(\mathbf{x}_0) e^{i \frac{[\beta_j(\omega_0) - \beta_m(\omega_0)]L}{\varepsilon^2}} \\ \times e^{Q_{jm}(\omega_0)L} f(t - \beta'_j(\omega_0)L) f(t - \beta'_m(\omega_0)L).$$

We see that it decays exponentially with the propagation distance because of the damping factors $\exp(Q_{jm}(\omega_0)L)$.

The second term is the contribution of the incoherent waves:

$$I_2^\varepsilon(t, \mathbf{x}, L) \stackrel{\varepsilon \rightarrow 0}{\simeq} \frac{1}{4} \sum_{j,l=1}^N \frac{\beta_l}{\beta_j} \phi_j^2(\mathbf{x}) \phi_l^2(\mathbf{x}_0) \int \mathcal{W}_j^{(l)}(\omega_0, \tau, L) f(t - \tau)^2 d\tau.$$

The mean transmitted intensity

For $L \gg L_{\text{equip}}$:

$$\lim_{\varepsilon \rightarrow 0} \mathbb{E} [p_{tr}^\varepsilon(t, \mathbf{x}, L)] \stackrel{L \gg L_{\text{equip}}}{\simeq} 0$$

$$\lim_{\varepsilon \rightarrow 0} \mathbb{E} [|p_{tr}^\varepsilon(t, \mathbf{x}, L)|^2] \stackrel{L \gg L_{\text{equip}}}{\simeq} H_{\omega_0, \mathbf{x}_0}(\mathbf{x}) \times [K_{\omega_0, L} * (f^2)](t),$$

where the spatial profile $H_{\omega_0, \mathbf{x}_0}$ and the time convolution kernel $K_{\omega_0, L}$ are

$$H_{\omega_0, \mathbf{x}_0}(\mathbf{x}) = \frac{1}{4N(\omega_0)} \sum_{j=1}^{N(\omega_0)} \frac{\phi_j^2(\mathbf{x})}{\beta_j(\omega_0)} \times \sum_{l=1}^{N(\omega_0)} \phi_l^2(\mathbf{x}_0) \beta_l(\omega_0),$$

$$K_{\omega_0, L}(t) = \frac{1}{\sqrt{2\pi\sigma_{\beta'(\omega_0)}^2 L}} \exp\left(-\frac{(t - \overline{\beta'(\omega_0)}L)^2}{2\sigma_{\beta'(\omega_0)}^2 L}\right).$$

Universal spatial profile (independent of the statistics of the perturbations).

Time profile:

$1/\overline{\beta'(\omega_0)}$: group velocity = harmonic average of the mode velocity.

$\sigma_{\beta'(\omega_0)}^2$: group velocity dispersion.

Modal dispersion $\sim \sqrt{L}$.

Strong random coupling \implies reduction of modal dispersion.

Time reversal setup

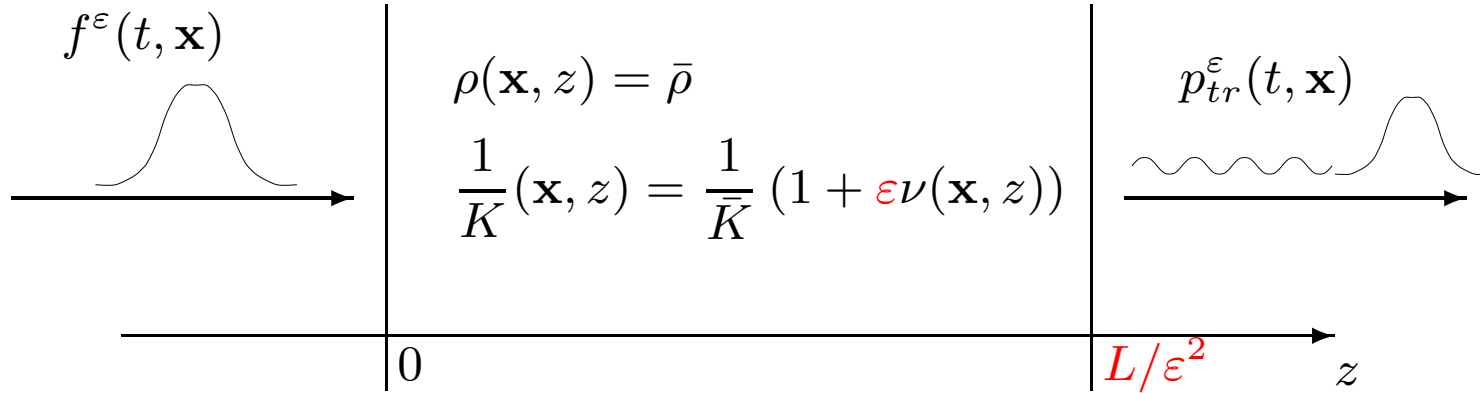

Record $p_{tr}^\varepsilon(t, \mathbf{x}, L)$ up to time t_1 on the mirror $\mathbf{x} \in \mathcal{D}_M \subset \mathcal{D}$.

Cut a piece $f_{TR}^\varepsilon(t, \mathbf{x}) = p_{tr}^\varepsilon(t, \mathbf{x}, L)G_1(t)G_2(\mathbf{x})$, with $\text{supp}(G_1) \subset [0, t_1]$ and $\text{supp}(G_2) \subset \mathcal{D}_M$.

Time reverse and re-emit $\mathbf{F}_{TR}^\varepsilon(t, \mathbf{x}, z) = f_{TR}^\varepsilon(t, \mathbf{x})\mathbf{e}_z$.

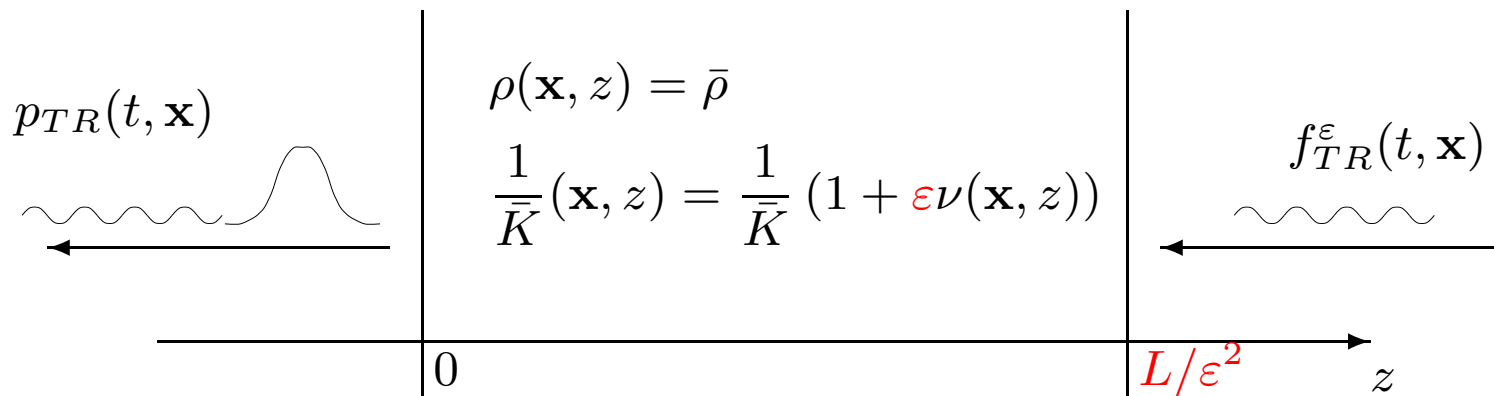

Mirror coupling coefficients:

$$M_{jl} = \int_{\mathcal{D}} \phi_j(\mathbf{x}) G_2(\mathbf{x}) \phi_l(\mathbf{x}) d\mathbf{x}$$

- If the mirror spans the complete cross section \mathcal{D} of the waveguide, then we have $G_2(\mathbf{x}) = 1$ and $M_{jl} = 1$ if $j = l$ and 0 otherwise.

- If the mirror is point-like at $\mathbf{x} = \mathbf{x}_1$, i.e. $G_2(\mathbf{x}) = \delta(\mathbf{x} - \mathbf{x}_1)$, then $M_{jl} = \phi_j(\mathbf{x}_1) \phi_l(\mathbf{x}_1)$.

Intuition for a "Good" mirror: M almost diagonal.

Refocused pulse after TR:

$$\begin{aligned} p_{\text{TR}} \left(\frac{t_{\text{obs}}}{\varepsilon^2}, \mathbf{x}, 0 \right) &= \frac{1}{8\pi^2} \sum_{j,l,m,n=1}^N \frac{\sqrt{\beta_l \beta_m}}{\sqrt{\beta_j \beta_n}} M_{mj} \phi_n(\mathbf{x}) \phi_l(\mathbf{x}_0) \\ &\times e^{i[\beta_m(\omega_0) - \beta_j(\omega_0)] \frac{L}{\varepsilon^2} + i\omega_0 \frac{t_1 - t_{\text{obs}}}{\varepsilon^2}} \\ &\times \int \int \overline{T_{jl}^\varepsilon(\omega_0 + \varepsilon^2 h')} T_{mn}^\varepsilon(\omega_0 + \varepsilon^2 h) \\ &\times \overline{\hat{f}(h')} \hat{G}_1(h - h') e^{i[\beta'_m(\omega_0) h' - \beta'_j(\omega_0) h] L + i h (t_1 - t_{\text{obs}})} dh dh' \end{aligned}$$

Simplification: $G_1 \equiv 1$ (record everything in time).

Homogeneous waveguide with a full mirror

Transfer matrix $T_{jl}^\varepsilon = \delta_{jl}$. Mirror coupling $M_{jl} = \delta_{jl}$.

$$p_{\text{TR}} \left(\frac{t_{\text{obs}}}{\varepsilon^2}, \mathbf{x}, 0 \right) = \frac{1}{2} e^{i\omega_0 \frac{t_1 - t_{\text{obs}}}{\varepsilon^2}} f(t_1 - t_{\text{obs}}) \sum_{j=1}^N \phi_j(\mathbf{x}) \phi_j(\mathbf{x}_0)$$

Planar waveguide with diameter d :

$$\left\{ \begin{array}{l} \phi_j(x) = \sqrt{2/d} \sin(\pi j x / d) \\ \lambda_j = \pi j / d \\ \beta_j = \sqrt{\omega^2 / c^2 - \pi^2 j^2 / d^2} \\ N(\omega) = [(\omega d) / (\pi \bar{c})] = [2d / \lambda_0] \end{array} \right. .$$

In the continuum limit $N \gg 1$ (i.e. $d \gg \lambda_0$) we have

$$\frac{1}{2} \sum_{j=1}^N \phi_j(x) \phi_j(x_0) \stackrel{N \gg 1}{\simeq} \frac{1}{\lambda_0} \text{sinc} \left(2\pi \frac{x - x_0}{\lambda_0} \right)$$

→ diffraction-limited spot size, with focal radius = $\lambda_0/2$.

Homogeneous waveguide with a partial mirror

Transfer matrix $T_{jl}^\varepsilon = \delta_{jl}$.

$$p_{\text{TR}} \left(\frac{t_{\text{obs}}}{\varepsilon^2}, \mathbf{x}, 0 \right) = \frac{1}{2} e^{i\omega_0 \frac{t_1 - t_{\text{obs}}}{\varepsilon^2}} \sum_{j,m=1}^N e^{i[\beta_m - \beta_j](\omega_0) \frac{L}{\varepsilon^2}} \\ \times M_{mj} \phi_m(\mathbf{x}) \phi_j(\mathbf{x}_0) f([\beta'_m - \beta'_j](\omega_0)L + t_1 - t_{\text{obs}})$$

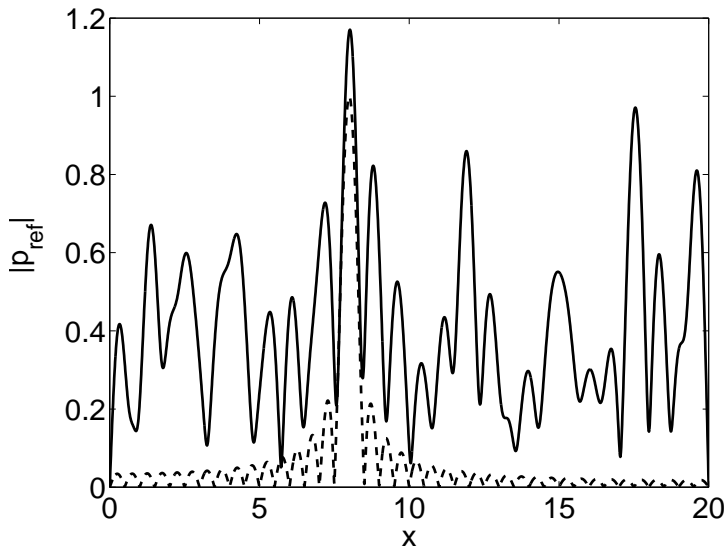

Mirror size $a = 2.5$

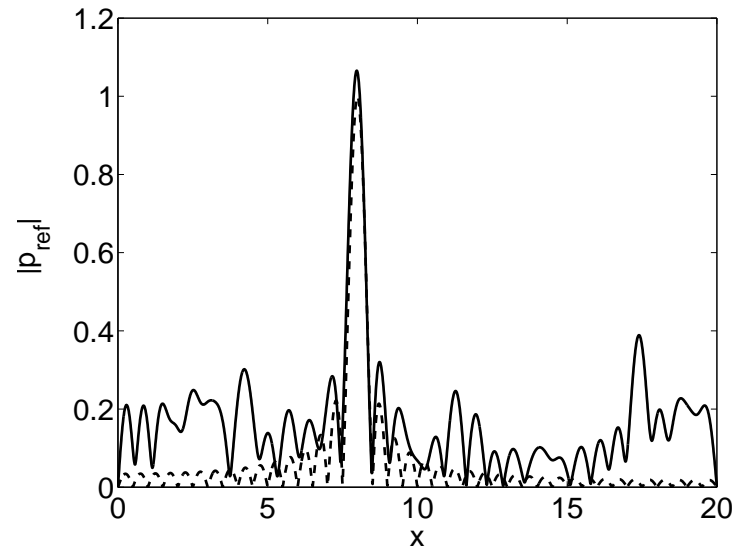

Mirror size $a = 10$

Transverse profile of the refocused field in a homogeneous waveguide with diameter $d = 20$ and length $L = 200$. Here $\lambda_0 = 1$, so there are 40 modes. Original source location is $x_0 = 8$.

The mean refocused pulse in a random waveguide

$$\mathbb{E} \left[p_{\text{TR}} \left(\frac{t_{\text{obs}}}{\varepsilon^2}, \mathbf{x}, 0 \right) \right] = p_1^\varepsilon + p_2^\varepsilon$$

p_1^ε is the contribution of the coherent waves:

$$p_1^\varepsilon \stackrel{\varepsilon \rightarrow 0}{\simeq} \frac{1}{2} \sum_{j \neq m=1}^N M_{mj} \phi_m(\mathbf{x}) \phi_j(\mathbf{x}_0) e^{i[\beta_m - \beta_j](\omega_0) \frac{L}{\varepsilon^2} + i\omega_0 \frac{t_1 - t_{\text{obs}}}{\varepsilon^2}} \\ \times e^{Q_{jm}(\omega_0)L} f([\beta'_m - \beta'_j](\omega_0)L + t_1 - t_{\text{obs}}),$$

p_2^ε is the contribution of the refocused incoherent waves:

$$p_2^\varepsilon \stackrel{\varepsilon \rightarrow 0}{\simeq} \frac{1}{2} e^{i\omega_0 \frac{t_1 - t_{\text{obs}}}{\varepsilon^2}} f(t_1 - t_{\text{obs}}) \sum_{j,l=1}^N M_{jj} \phi_l(\mathbf{x}) \phi_l(\mathbf{x}_0) \int \mathcal{W}_j^{(l)}(\omega_0, L, d\tau)$$

In the equipartition regime:

$$\lim_{\varepsilon \rightarrow 0} \mathbb{E} \left[p_{\text{TR}} \left(\frac{t_{\text{obs}}}{\varepsilon^2}, \mathbf{x}, 0 \right) \right] \stackrel{L \gg L_{\text{equip}}}{\simeq} e^{i\omega_0 \frac{t_1 - t_{\text{obs}}}{\varepsilon^2}} f(t_1 - t_{\text{obs}}) \\ \times \frac{1}{N(\omega_0)} \sum_j^{N(\omega_0)} M_{jj} \times \frac{1}{2} \sum_{l=1}^{N(\omega_0)} \phi_l(\mathbf{x}) \phi_l(\mathbf{x}_0)$$

In the equipartition regime:

$$\lim_{\varepsilon \rightarrow 0} \left| \mathbb{E} \left[p_{\text{TR}} \left(\frac{t_{\text{obs}}}{\varepsilon^2}, \mathbf{x}, 0 \right) \right] \right| \stackrel{L \gg L_{\text{equip}}}{\sim} \frac{1}{N(\omega_0)} \sum_j^{N(\omega_0)} M_{jj} \times \frac{1}{2} \sum_{l=1}^{N(\omega_0)} \phi_l(\mathbf{x}) \phi_l(\mathbf{x}_0)$$

Off-diagonal terms $j \neq m$ are killed by the expectation.

$$\text{Planar waveguide: } \begin{cases} \phi_j(x) = \sqrt{2/d} \sin(\pi j x / d) \\ \beta_j = \sqrt{\omega^2 / c^2 - \pi^2 j^2 / d^2} \\ \lambda_j = \pi j / d, \quad N(\omega) = [(\omega d) / (\pi c)] = [2d / \lambda_0] \end{cases} .$$

In the continuum limit $N \gg 1$ we have

$$\frac{1}{2} \sum_{l=1}^N \phi_l(x) \phi_l(x_0) \stackrel{N \gg 1}{\simeq} \frac{1}{\lambda_0} \text{sinc} \left(2\pi \frac{x - x_0}{\lambda_0} \right)$$

→ **diffraction-limited spot size.**

→ **holds true only in average.**

Statistical stability

$$S^2 := \lim_{\varepsilon \rightarrow 0} \frac{\mathbb{E} \left[\left| p_{\text{TR}} \left(\frac{t_{\text{obs}}}{\varepsilon^2}, \mathbf{x}_0, 0 \right) \right|^2 \right] - \left| \mathbb{E} \left[p_{\text{TR}} \left(\frac{t_{\text{obs}}}{\varepsilon^2}, \mathbf{x}_0, 0 \right) \right] \right|^2}{\left| \mathbb{E} \left[p_{\text{TR}} \left(\frac{t_{\text{obs}}}{\varepsilon^2}, \mathbf{x}_0, 0 \right) \right] \right|^2}$$

We have statistical stability when S is small. In the equipartition regime :

$$S^2 \stackrel{L \gg L_{\text{equip}}}{\simeq} -\frac{1}{N+1} + \frac{N}{N+1} \frac{1}{Q_{\text{mirror}}}, \quad Q_{\text{mirror}} = \frac{\sum_{j,l} M_{jj} M_{ll}}{\sum_{j,l} M_{jl}^2}$$

The quality factor Q_{mirror} depends only on the time reversal mirror.

Two extreme cases:

- If the time reversal mirror spans the waveguide cross-section, then $M_{jl} = \delta_{jl}$,

$Q_{\text{mirror}} = N$ and $S^2 = 0$, which is optimal.

- If the time reversal mirror is point-like at \mathbf{x}_1 , then $M_{jl} = \phi_j(\mathbf{x}_1)\phi_l(\mathbf{x}_1)$,

$Q_{\text{mirror}} = 1$, and $S^2 = (N-1)/(N+1)$.

Numerical illustration: planar waveguide

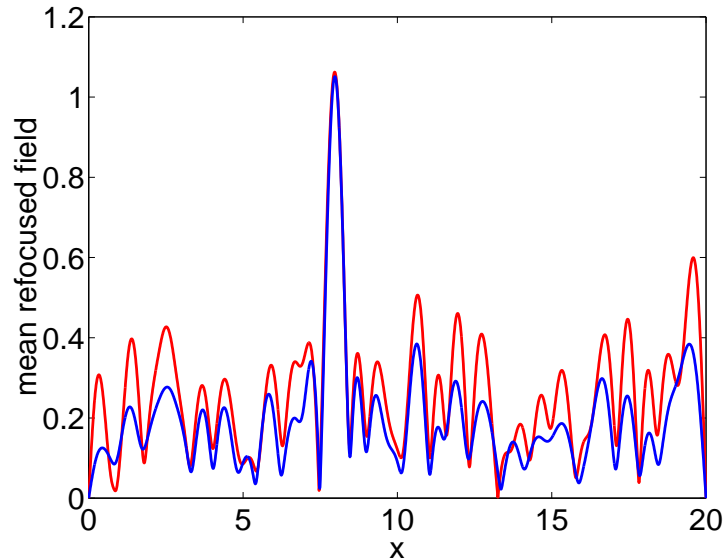

$$\sigma = 0.005$$

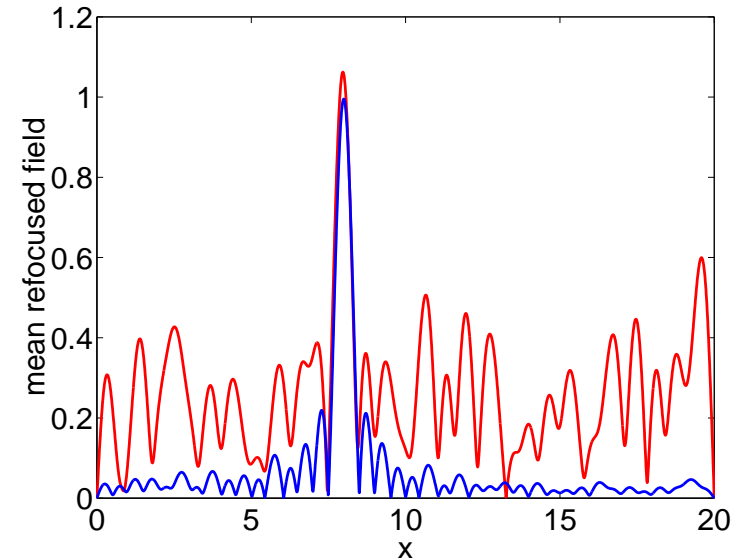

$$\sigma = 0.015$$

Transverse profile of the **mean refocused field** in a random waveguide with diameter $d = 20$, length $L = 200$, $\lambda_0 = 1$, mirror size $a = 5$, original source location $x_0 = 8$.

Random medium: correlation length $l_c = 0.25$ and standard deviation σ .

Red lines: spatial profile obtained in homogeneous medium $\sigma = 0$.

Blue lines: mean profile in a random waveguide.

Right figure is very close to the equipartition regime.

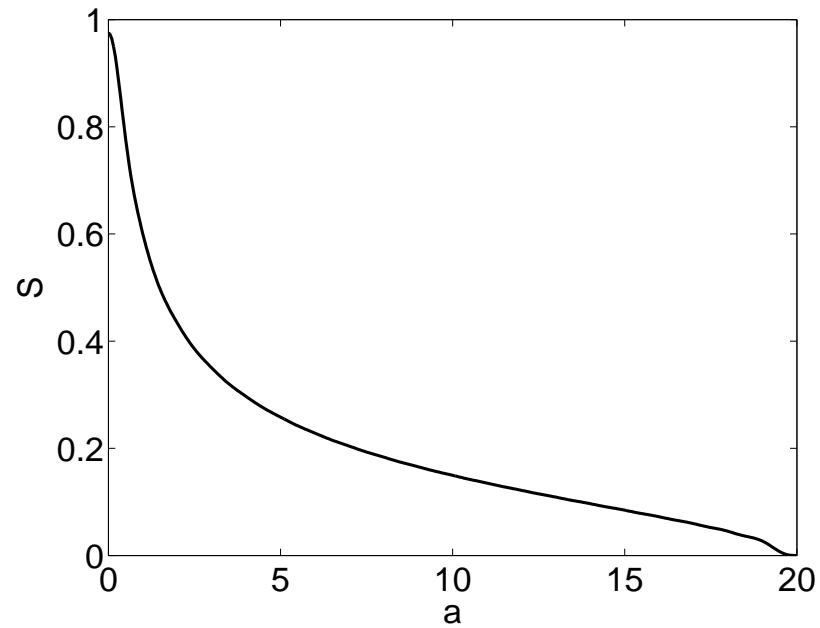

The relative standard deviation S of the refocused field in the equipartition regime as a function of the mirror size a . Here $d = 20$ and $\lambda_0 = 1$.

Numerical simulations: planar waveguide

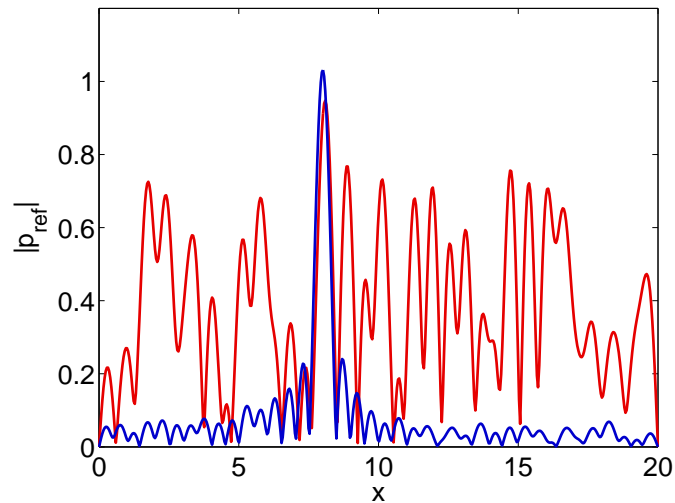

$$a = 2.5$$

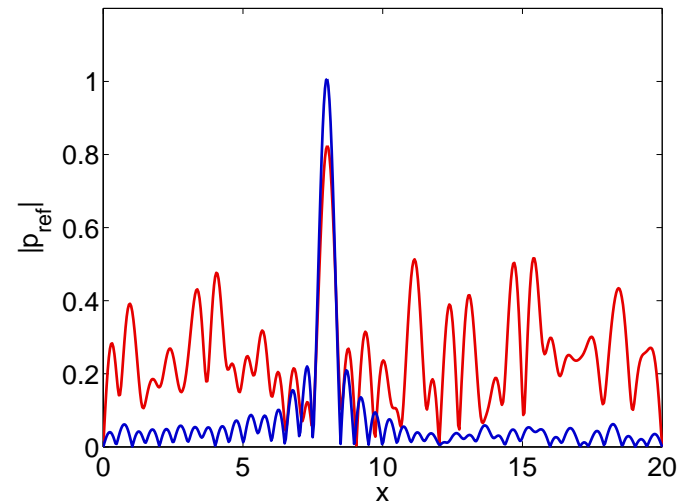

$$a = 5$$

Transverse profile of the **refocused field** in a random waveguide with diameter $d = 20$, length $L = 200$, $\lambda_0 = 1$, mirror diameter a , original source location $x_0 = 8$.

Red lines: spatial profile obtained for **a particular realization** of the random medium.

Blue lines: mean profiles **averaged** over 100 realizations.

Parameters close to the equipartition regime.

Numerical simulations: planar waveguide

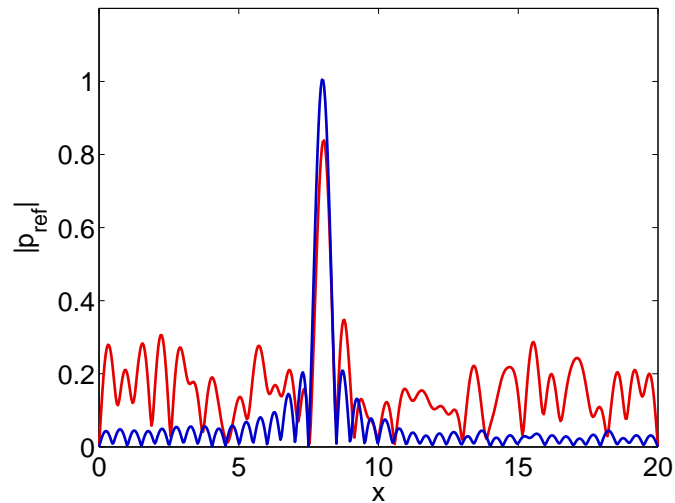

$a = 10$

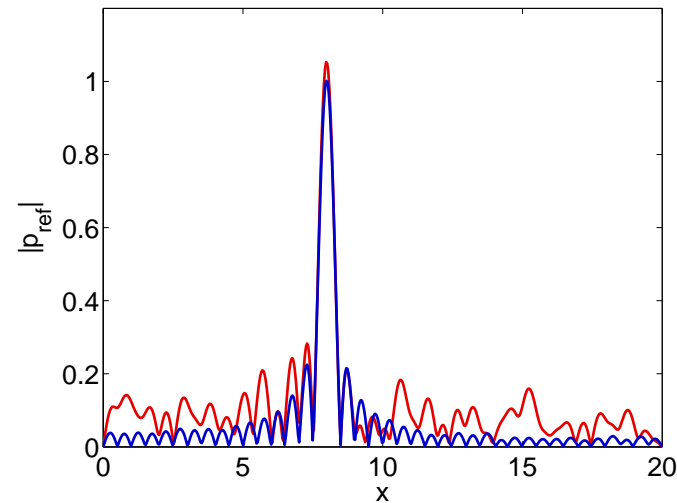

$a = 15$

Transverse profile of the **refocused field** in a random waveguide with diameter $d = 20$, length $L = 200$, $\lambda_0 = 1$, mirror diameter a , original source location $x_0 = 8$.

Red lines: spatial profile obtained for **a particular realization** of the random medium.

Blue lines: mean profiles **averaged** over 100 realizations.

Parameters close to the equipartition regime.

Conclusions

Mechanisms responsible for statistical stability in time-reversal:

1) broadband pulse

large number of uncorrelated frequency components

⇒ self-averaging in time.

2) large mirror

large number of uncorrelated spatial modes

⇒ self-averaging even for time-harmonic waves.